

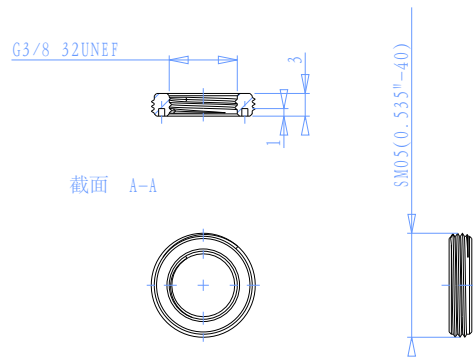

比例 1.000

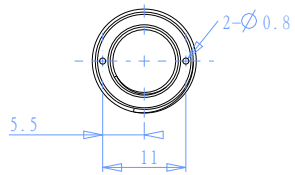

截面 A-A

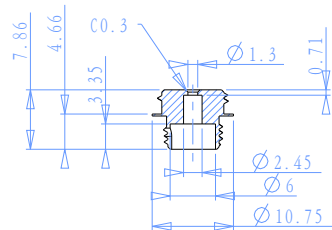
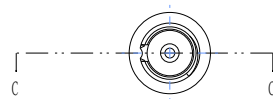
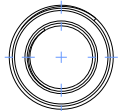

截面 C-C
比例 1.000

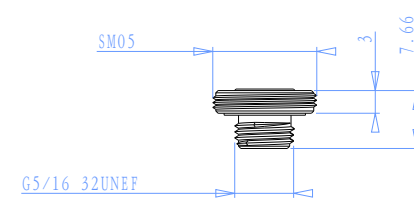
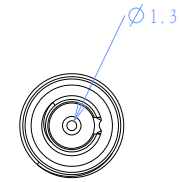
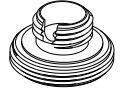
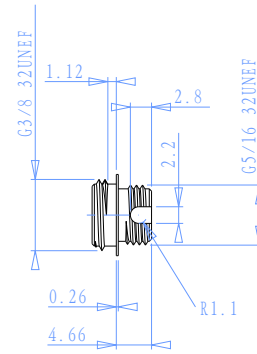

技术要求:

1. 材料规格: SUS304+AL6061
2. 外观要求: 表面光洁, 平整, 无碰划伤锐边磨圆, 未注倒角为C0.2
3. 未注公差; 按GB1804-f。
4. 氧化黑色

DRAWING PROJECTION		 Optics Experiment and Basic Teaching	
DATE	14/10/20		
SM05-FC25			
www.Oeabt.com	MATERIAL #		REV
COPYRIGHT © 2020 BY Oeabt			A
VALUE IN PARENTHESIS ARE CALCULATED AND MAY CONTAIN ROUND OFF ERRORS		APPROX WEIGHT	kg